

In 2020 the FCC announced the allocation of a new frequency spectrum for Wi-Fi applications, extending the frequencies up to 7125 MHz. The FlexMIMO 6E two-port MIMO antenna supports this extended Wi-Fi of 2400-2500, 4900-5925, and 5925-7125 MHz.

The FlexMIMO 6E also drastically simplifies the size, cost, and technical requirements for implementing the two antennas required for 802.11 modules that use MIMO or WiFi diversity.

Designed for rapid integration into space-constrained devices and housings, the flexible, adhesive-backed antennas are available with MHF1 or MHF4L connectors, providing multiple installation solutions for IoT device manufacturers.

The FlexMIMO technology provides consistent, stable performance across all three Wi-Fi bands, ensuring a solid and reliable connection at all times.

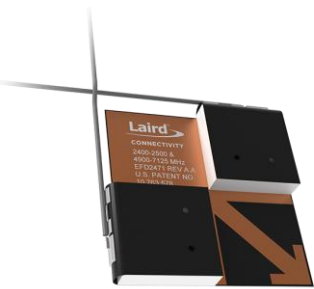

FEATURES AND BENEFITS

- **Full Coverage** – Operates over all three Wi-Fi bands
- **Performance** – Exceptional performance across all bands
- **Versatile** – Flexible, peel-and-stick adhesive-backed antenna for a variety of space-constrained IoT devices.
- **Future-Proofed** – Coverage for emerging Wi-Fi 6E applications.
- **Reliable** – PIFA technology is easy to integrate into IoT devices and less likely to detune in proximity of metal or a human body.
- **Quality** – Designed and built to exact specifications.

APPLICATIONS

- Smart metering and utilities
- Industrial IoT
- Agricultural and rural (Farm sense and control)
- Quick service restaurants
- Smart lockers
- Medical devices

ELECTRICAL SPECIFICATIONS

Number of Ports	2		
Operating Frequency (MHz)	2400-2500	4900-5925	5925-7125
VSWR – Average	1.9:1	1.8:1	1.8:1
VSWR – Maximum	< 3.0:1	< 3.0:1	< 3.0:1
Minimum Isolation (dB)	15	15	15
Maximum Peak Gain – (dBi) *	2.2	3.8	3.3
Efficiency – Average (%)	64	63	52
Efficiency – Average (dB)	-1.9	-2.0	-2.8
Nominal Impedance (Ohms)	50		
Maximum Power - Ambient 25°C (W)	10		
Polarization	Linear		

Note: Measured on a 100 mm x 100 mm x 1.5 mm thick polycarbonate sheet.

* Actual peak gain values can be influenced by measurement variation and other uncertainties.

MECHANICAL SPECIFICATIONS

Dimensions – length x width x height – inches (mm)	39.5 x 39.5 x 4.7 (1.56 x 1.56 x 0.19)
Weight – g (oz.)	3.3 grams
Adhesive	3M VHB 4955

ENVIRONMENTAL SPECIFICATIONS

Operating Temperature – °C (°F)	-40 to +85°C (-40 to +185°F)
Storage Temperature – °C (°F)	-40 to +85°C (-40 to +185°F)
Material Substance Compliance	RoHS

CONFIGURATION

PART NUMBER	EXPOSED CABLE LENGTH/DIAMETER	CONNECTOR
EFD2471A3S-10MHF1	100 mm/1.13 mm	MHF1
EFD2471A3S-10MH4L	100 mm/1.13 mm	MHF4L

MECHANICAL DRAWING

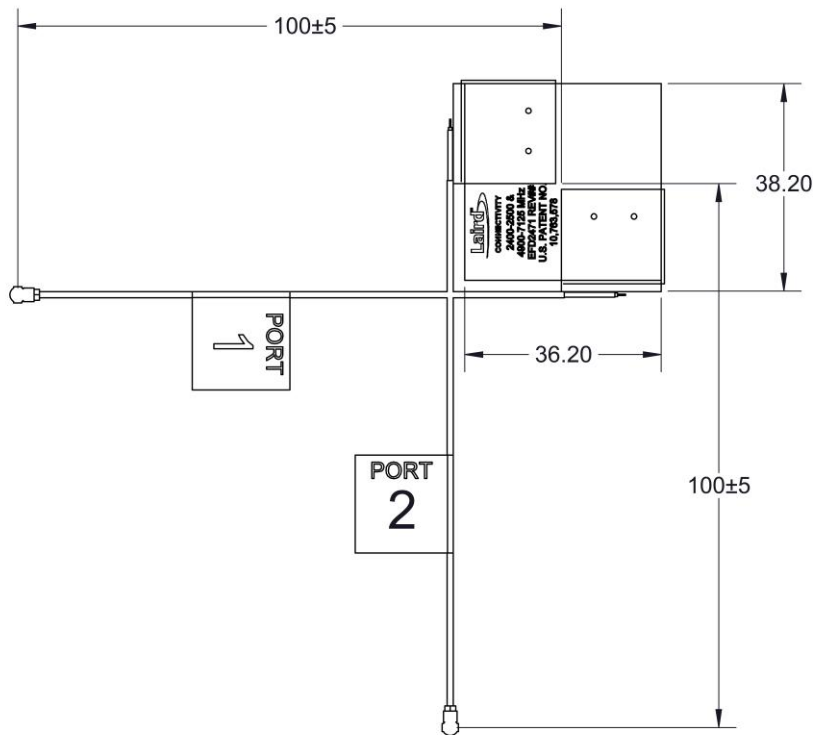

ANTENNA CHAMBER SETUP:

An Anechoic Antenna chamber using the Howland 3100 Dual Positioner System Is used. The Theta positioner rotates from 0 to 165 degrees. For each value of Theta, the Phi positioner rotates from 0 to 360 degrees.

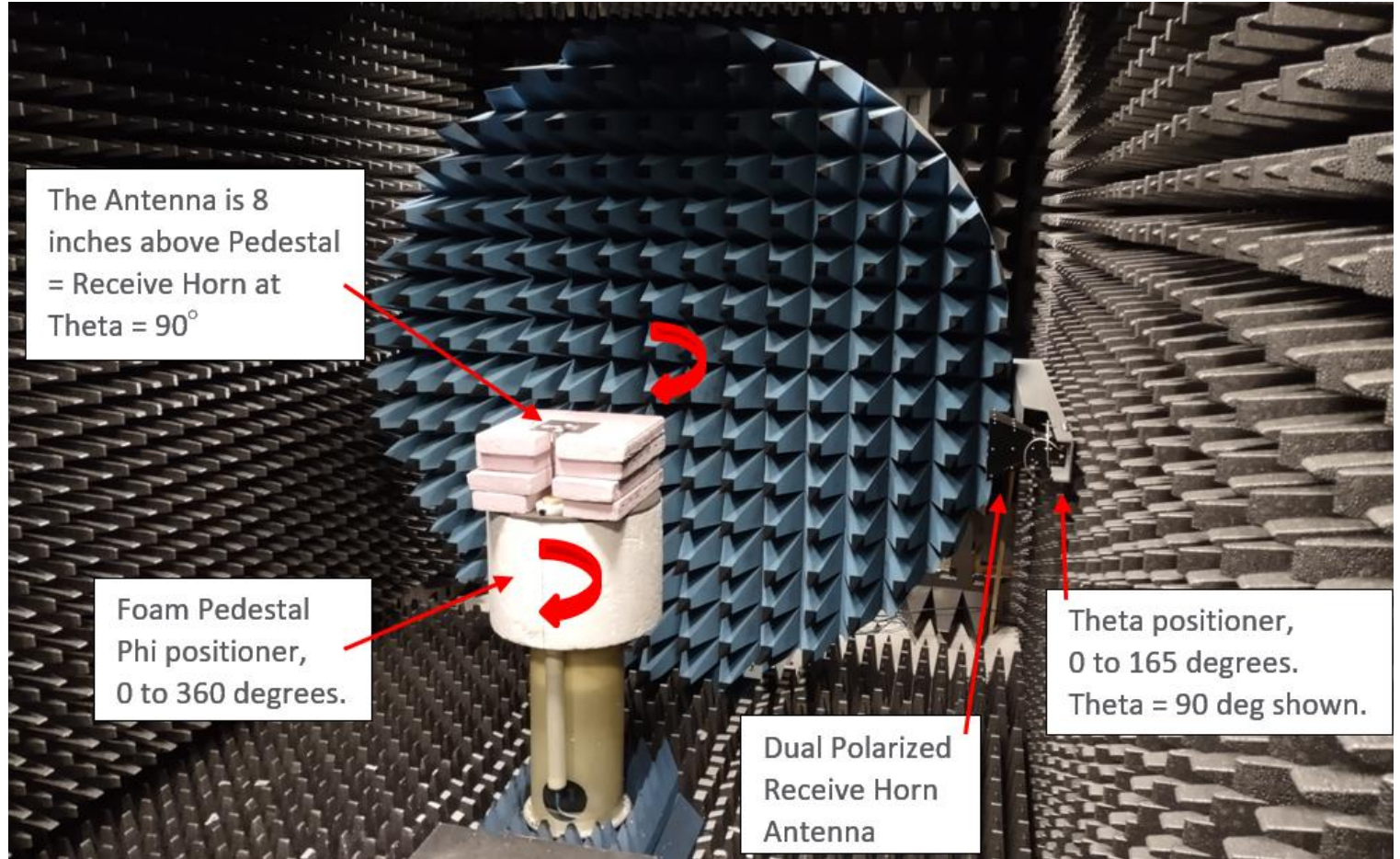

Port 1:

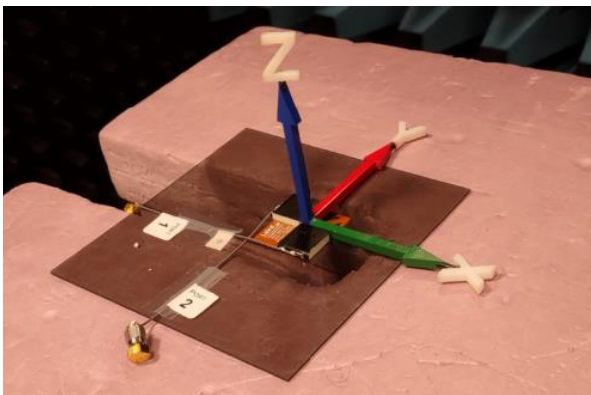

Port 2:

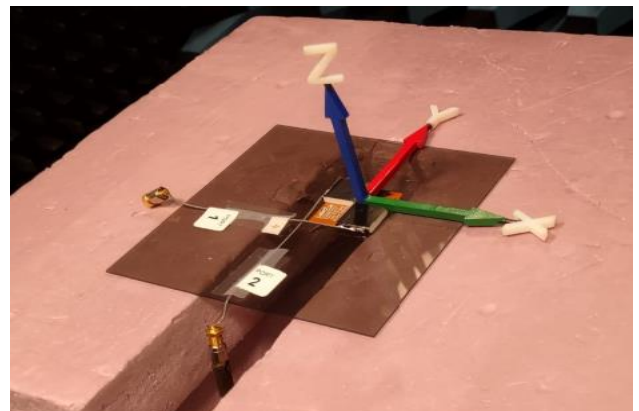

3D Measurement Coordinate System

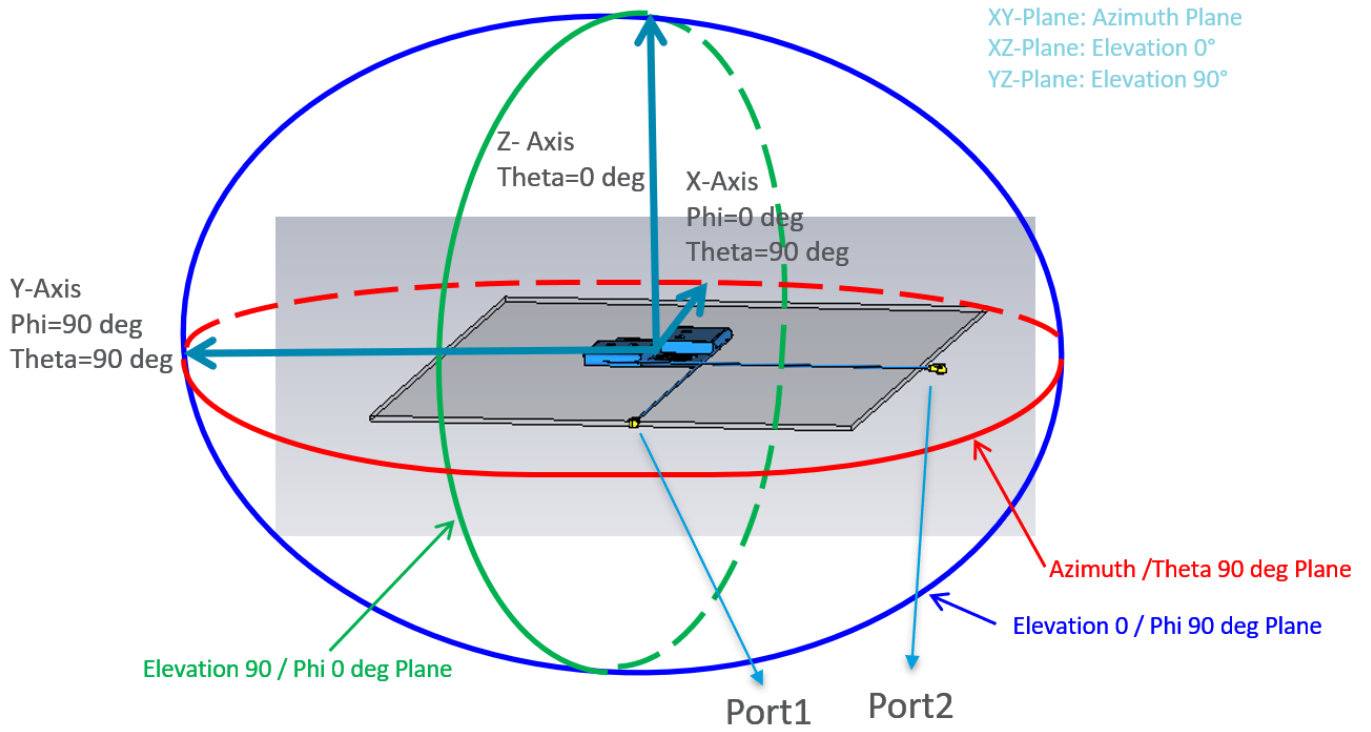

GAIN PATTERNS:

Port 1 Total Gain Pattern at 2400 MHz:

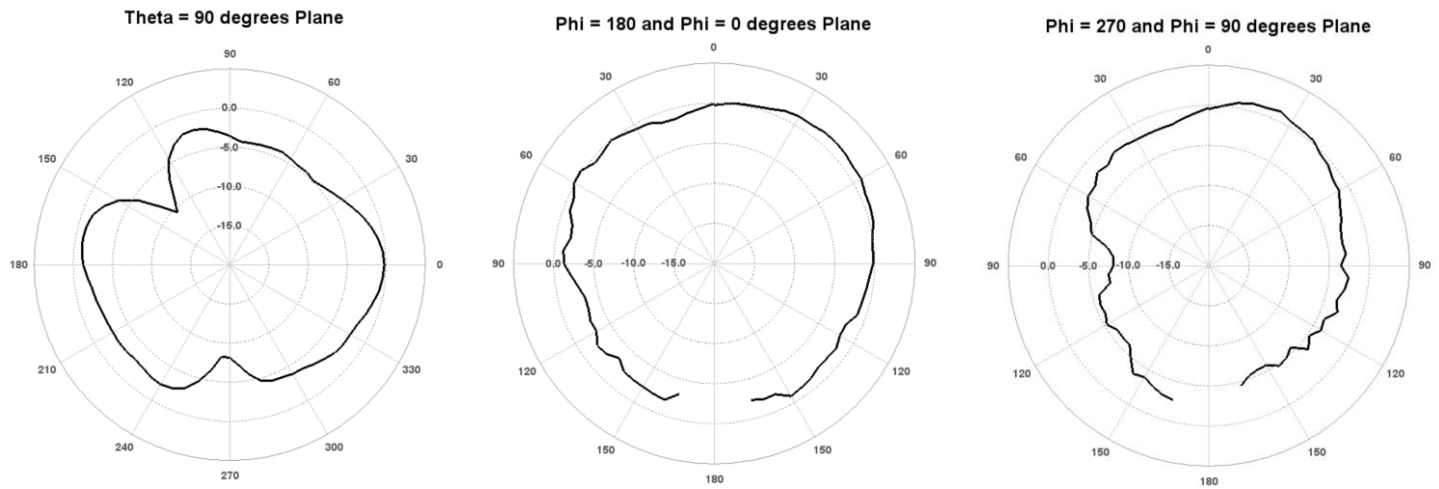

Port 2 Total Gain Pattern at 2400 MHz:

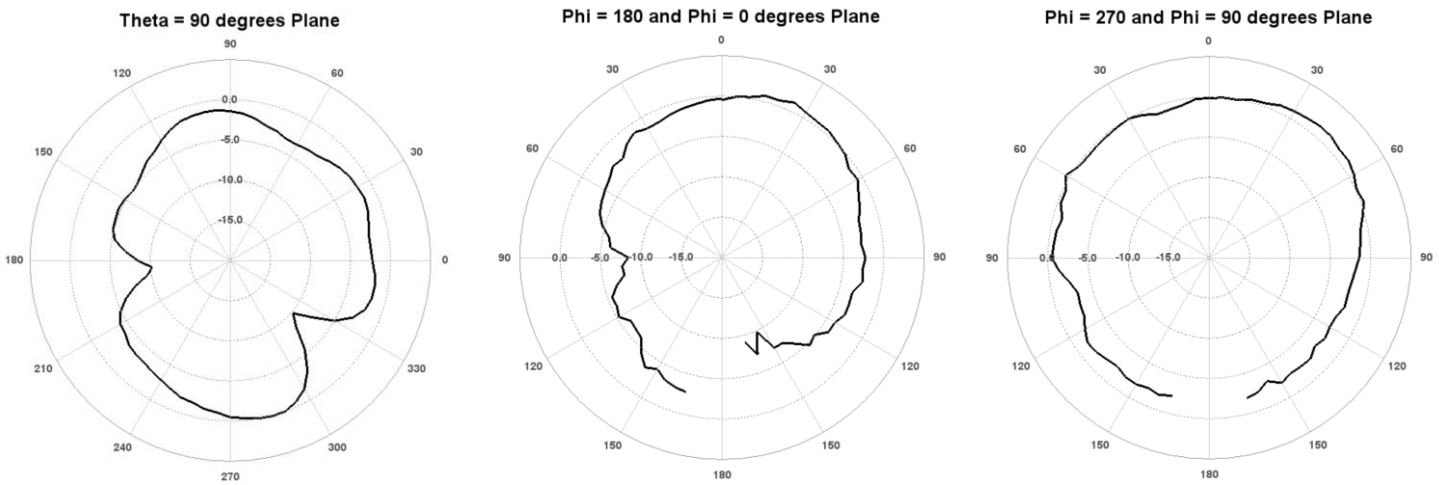

Port 1 Total Gain Pattern at 2450 MHz:

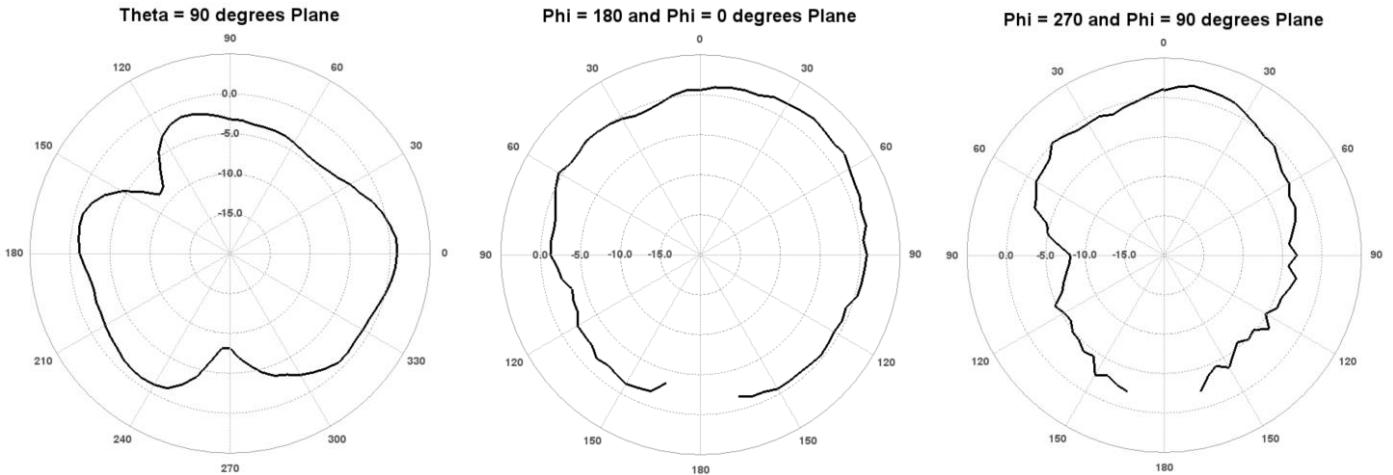

GAIN PATTERNS:

Port 2 Total Gain Pattern at 2450 MHz:

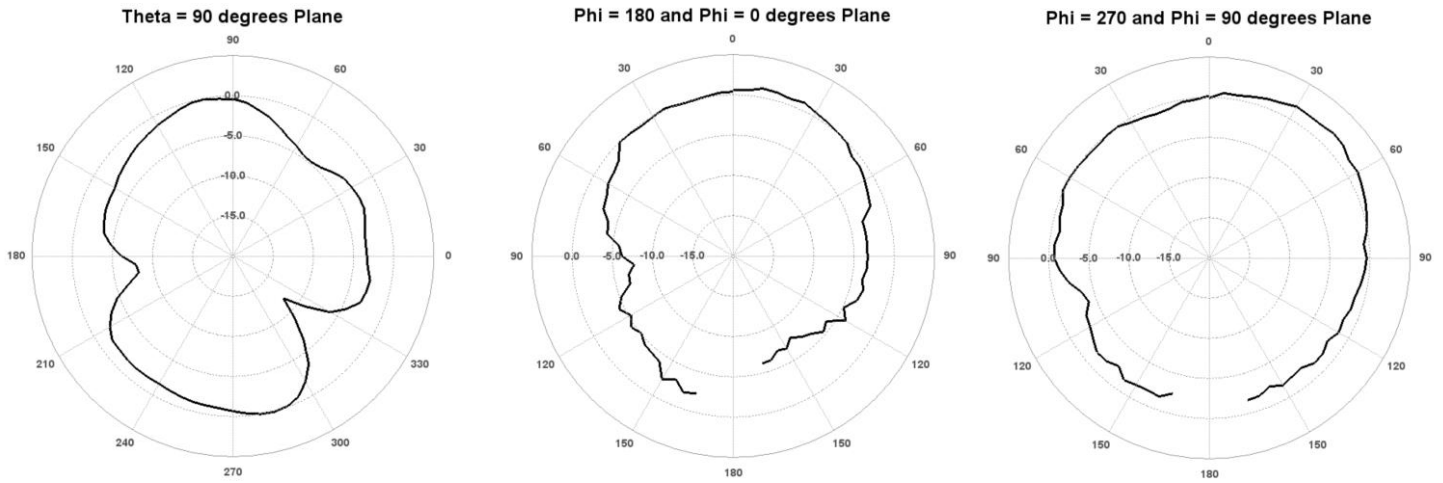

Port 1 Total Gain Pattern at 2500 MHz:

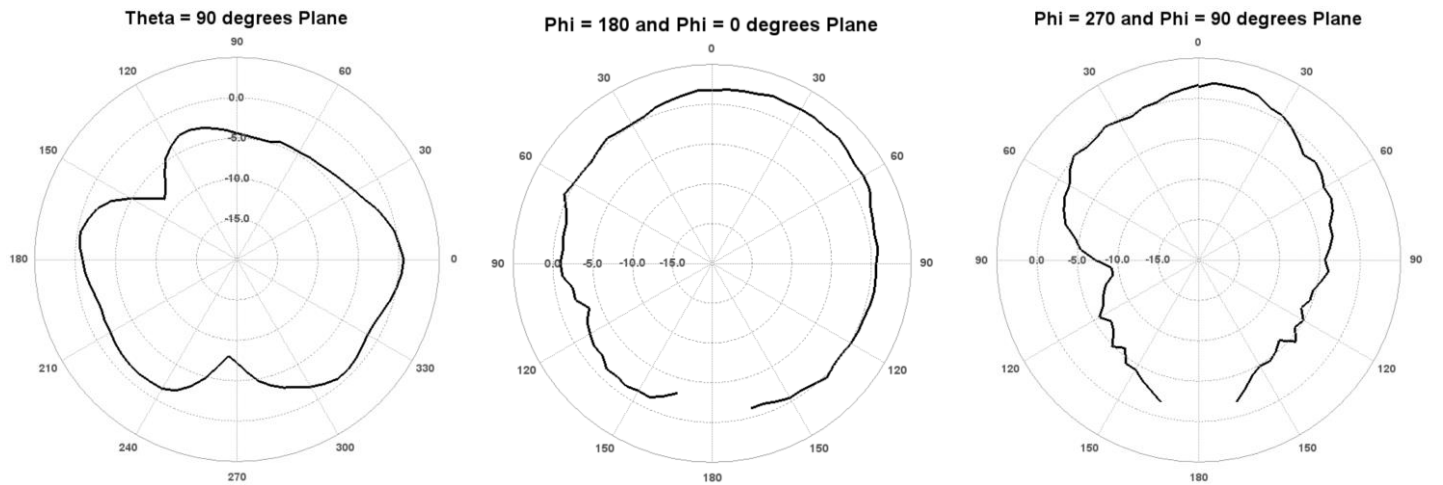

Port 2 Total Gain Pattern at 2500 MHz:

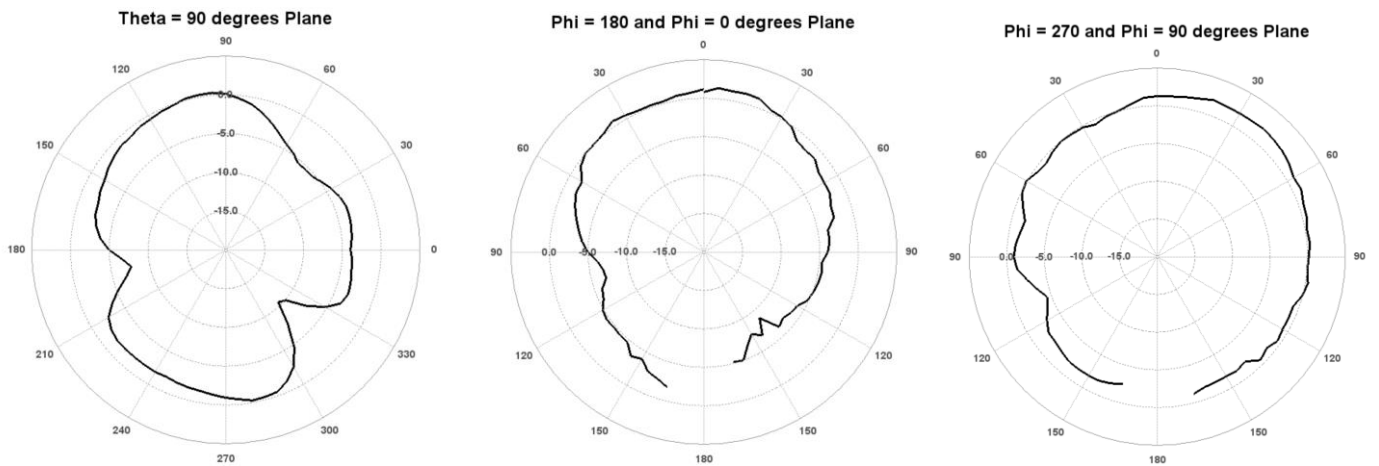

GAIN PATTERNS

Port 1 Total Gain Pattern at 4900 MHz:

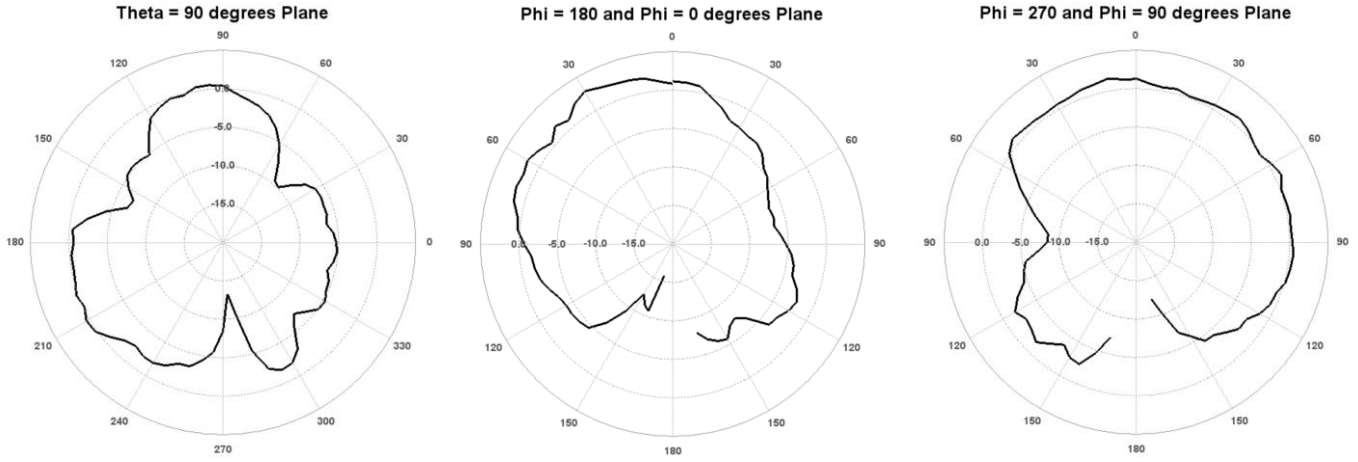

Port 2 Total Gain Pattern at 4900 MHz:

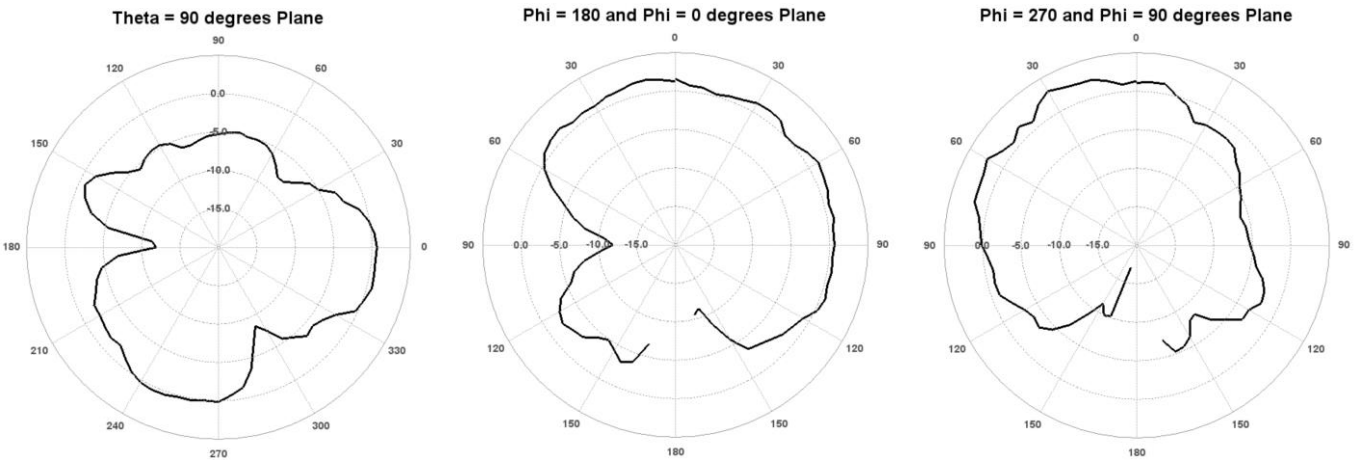

Port 1 Total Gain Pattern at 5250 MHz:

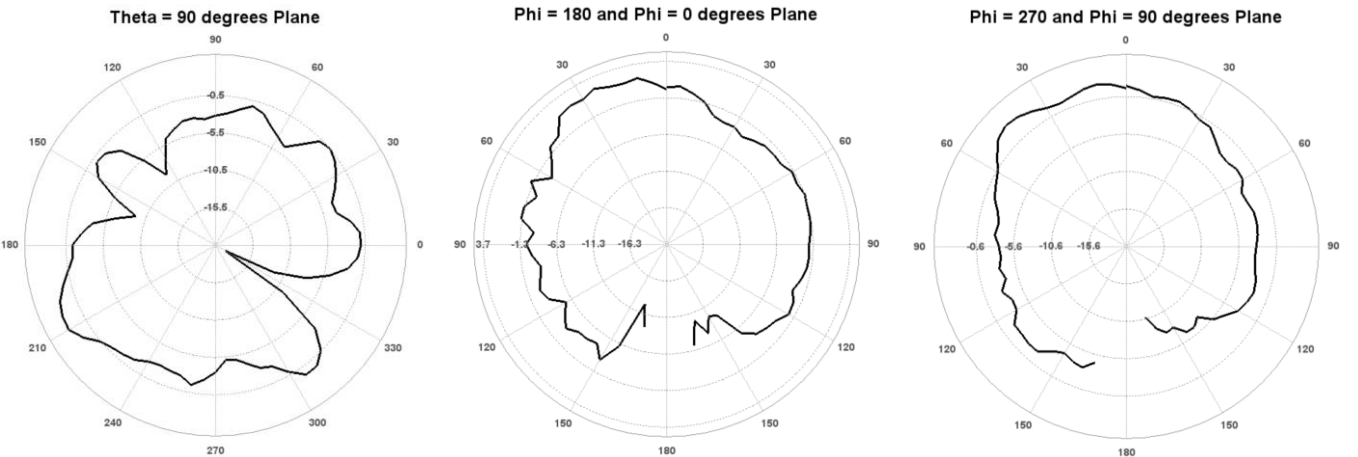

GAIN PATTERNS

Port 2 Total Gain Pattern at 5250 MHz:

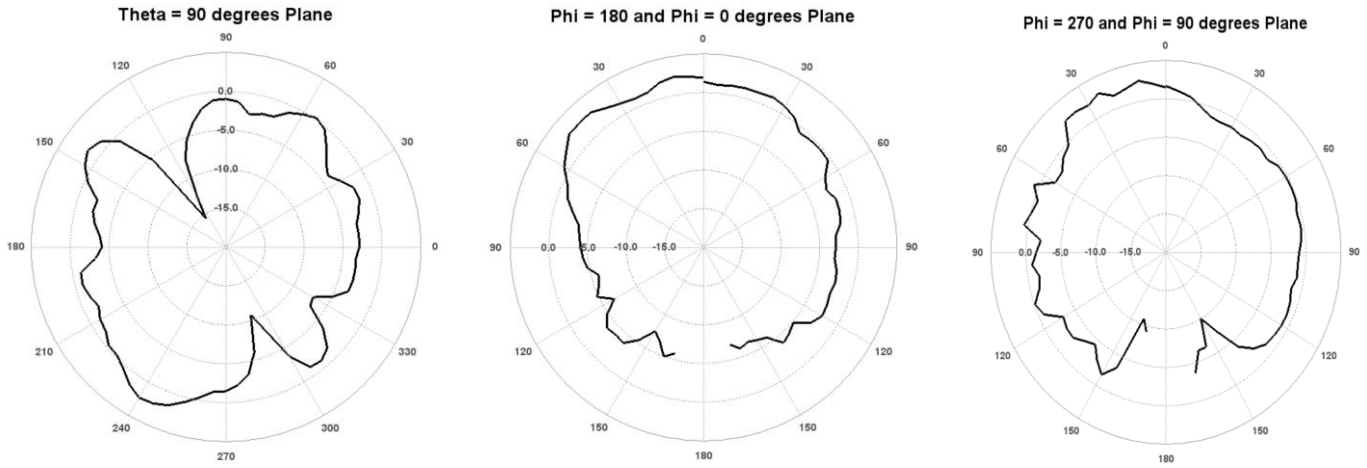

Port 1 Total Gain Pattern at 5600 MHz:

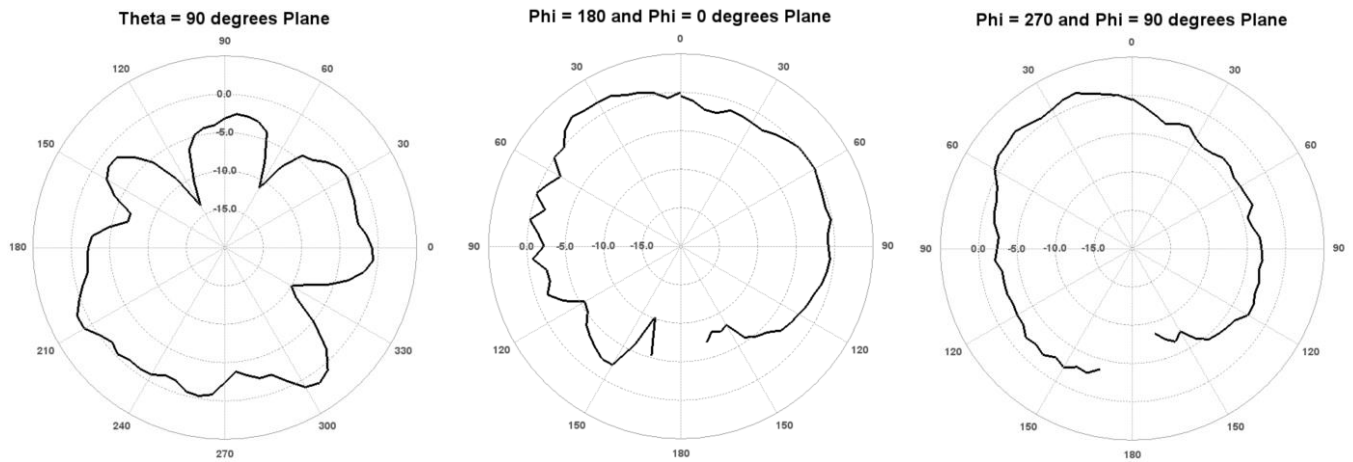

Port 2 Total Gain Pattern at 5600 MHz:

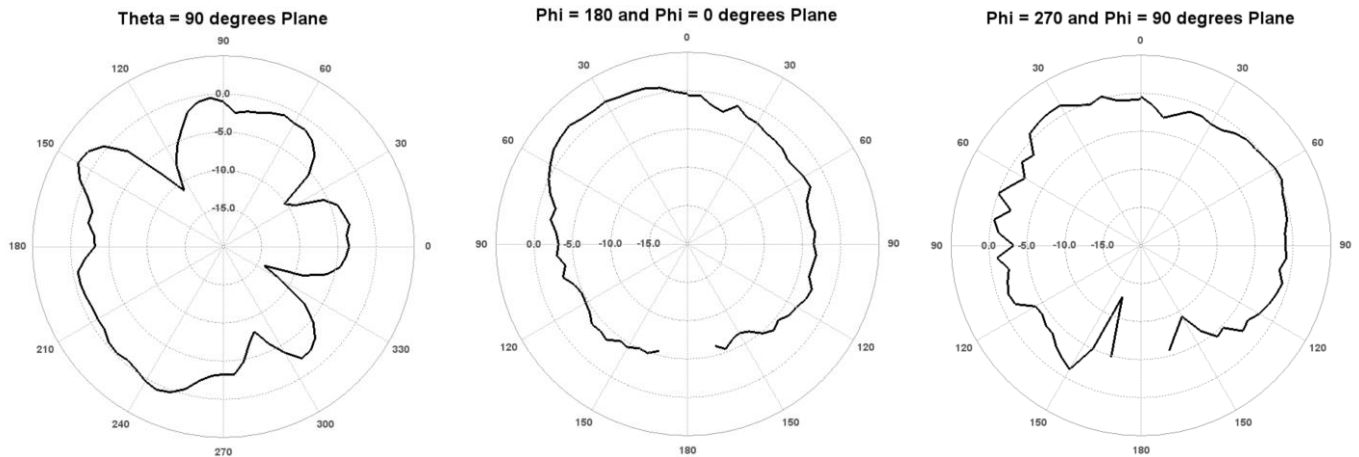

GAIN PATTERNS

Port 1 Total Gain Pattern at 5925 MHz:

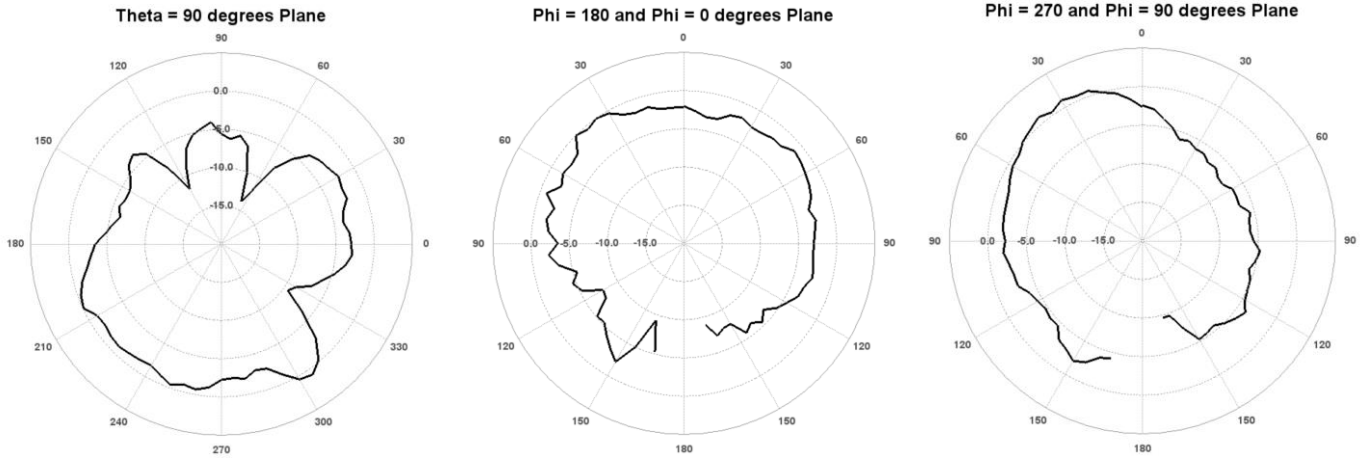

Port 2 Total Gain Pattern at 5925 MHz:

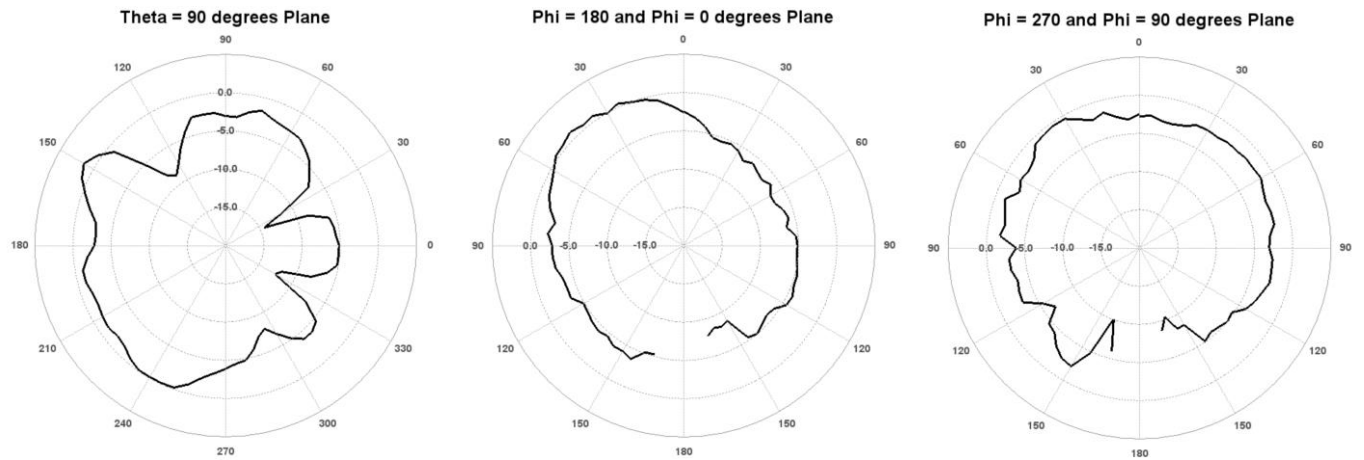

Port 1 Total Gain Pattern at 6525 MHz:

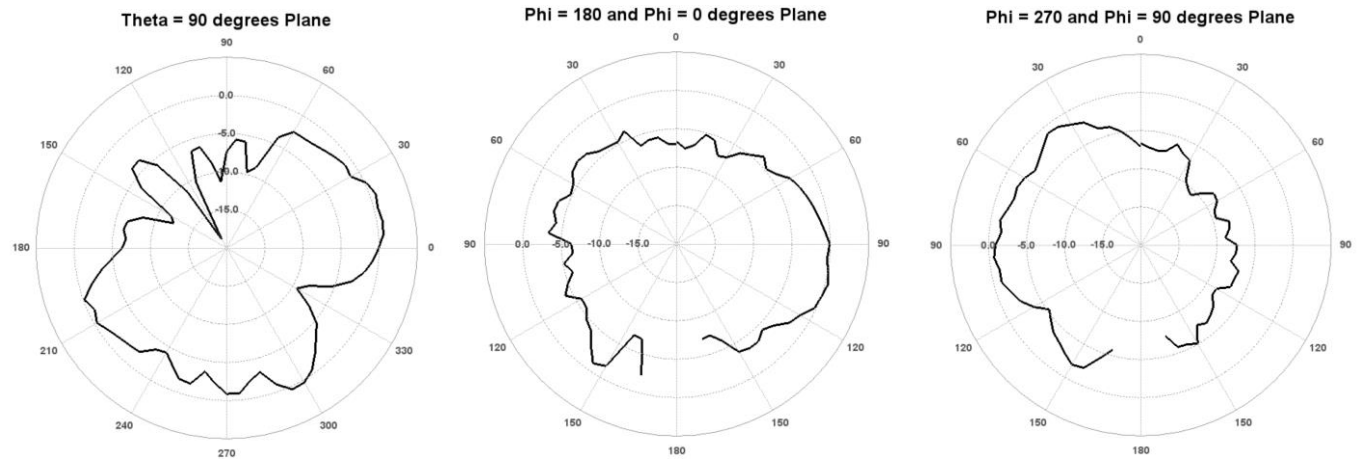

GAIN PATTERNS

Port 2 Total Gain Pattern at 6525 MHz:

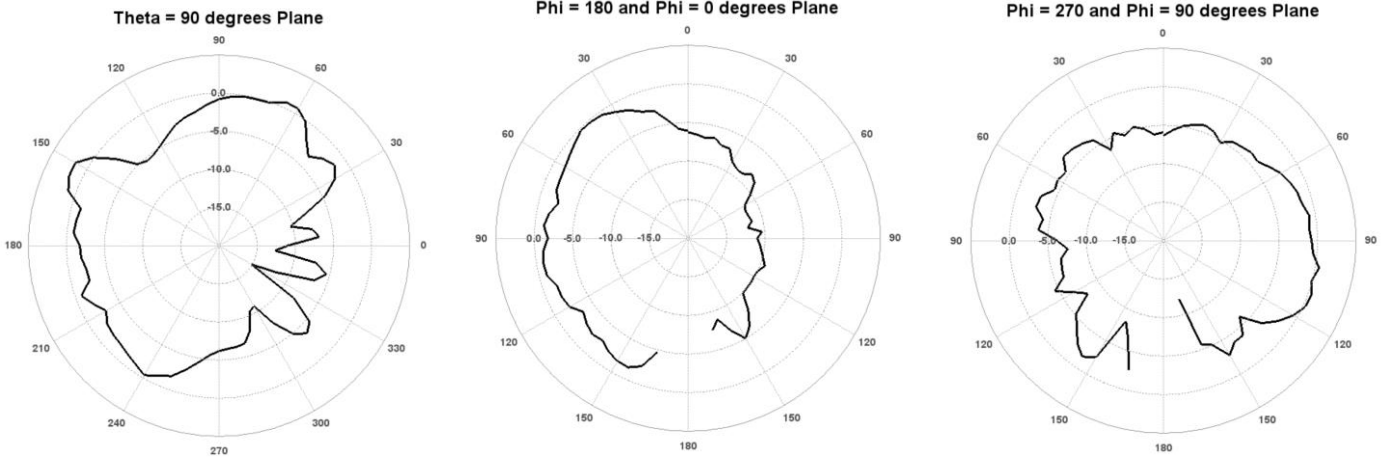

Port 1 Total Gain Pattern at 7125 MHz:

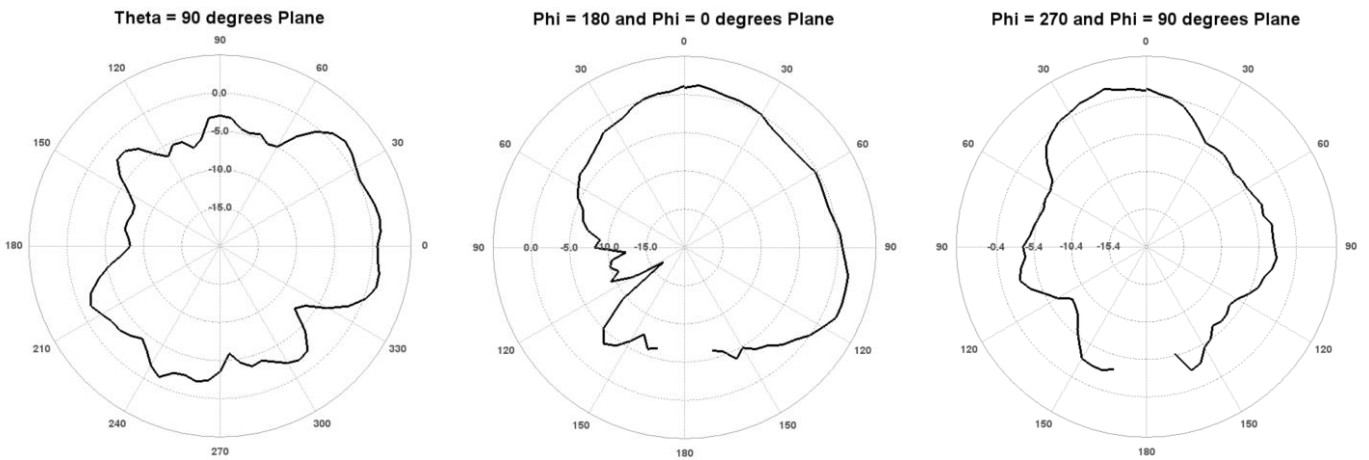

Port 2 Total Gain Pattern at 7125 MHz:

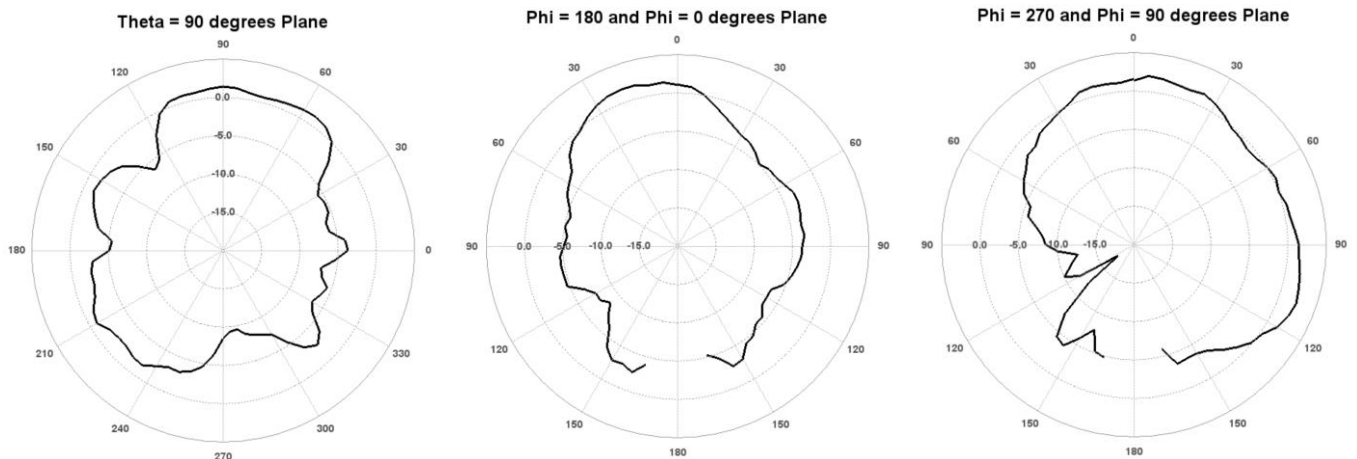

PRODUCT PLACEMENT

1.1 Initial Placement

The FlexPIFA is designed to be attached to dielectric surfaces encountered in plastic packaging of wireless communications devices. The nominal attachment surface used in its design and characterization is a 100 mm x 100 mm, 1.5-millimeter thick, Polycarbonate sheet. The antenna should be centered within the lateral plane of the dielectric sheet as shown in Figure 1.

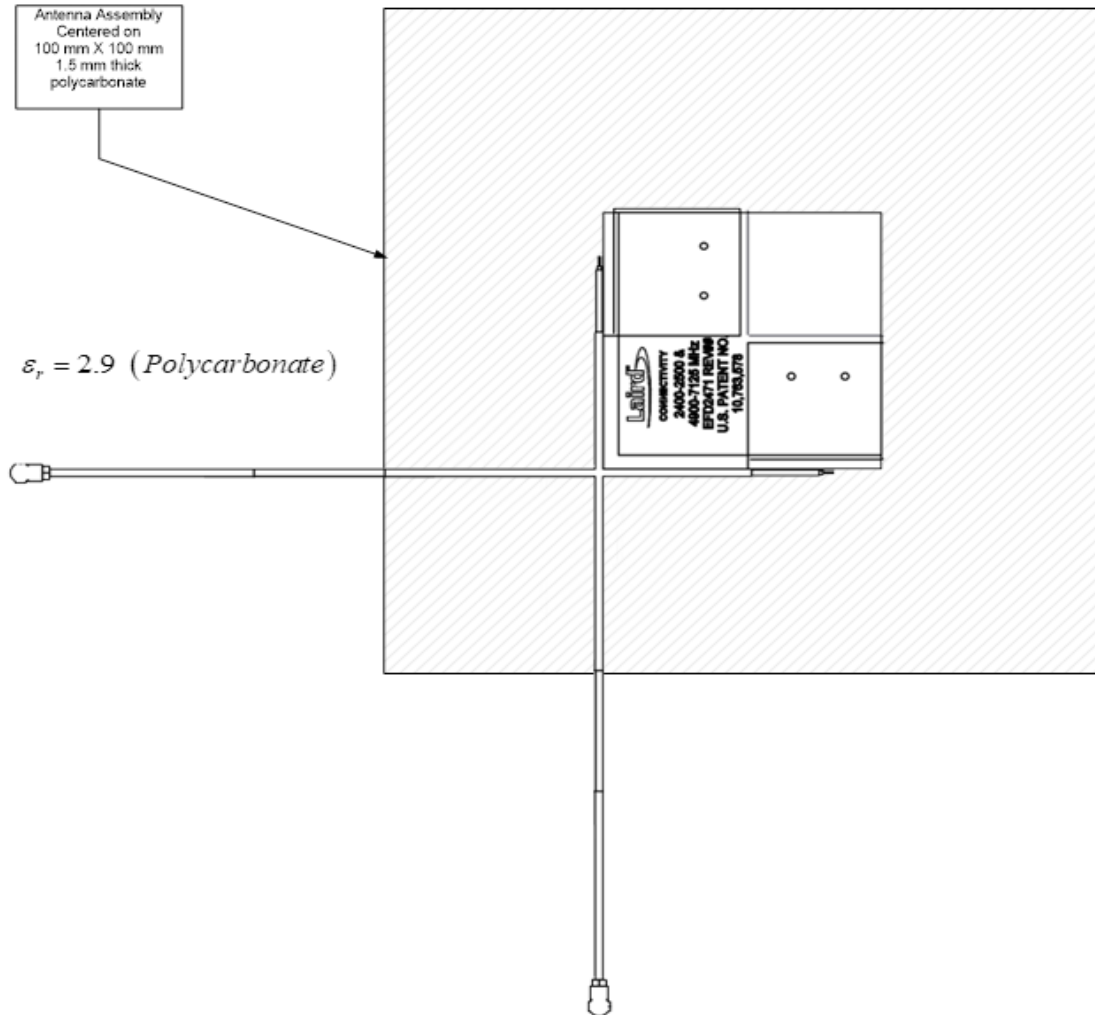

Figure 1: Nominal placement of FlexPIFA MIMO Antenna array on 100 mm X 100 mm, 1.5 mm thick, polycarbonate sheet

1.2 Additional Placement Information

The VSWR for both ports of the FlexMIMO 6E is < 3.0 for the following materials and thicknesses:

	Material	thickness (mm)
1	ABS	1.6
2	Acrylic	1.5
3	Delrin	1.7
4	FR4	1.5
5	Nylon	0.8
6	Nylon	1.6
7	Polycarbonate	0.9
8	Polycarbonate	1.6
9	Polycarbonate	3.1
10	Polycarbonate	6.1
11	PETG	1.5
12	Polypropylene	1.6
13	PVC tube 60.6 mm Outside Diameter	4.5
14	PVC tube 51.6 mm Inside Diameter	4.5

Co-Planar Ground Plane Edge Coupling and Clearance

The recommended minimum spacing between the ground plane and the antenna array is 5 millimeters to minimize any performance degradations to the reflection parameters (VSWR, Return Loss), spatially averaged gain (efficiency), or peak spatial gain (directivity). The drawings presented in Figure 2 and Figure 3 represent the proper clearance between the antenna array and a co-planar and edge-coupled ground plane.

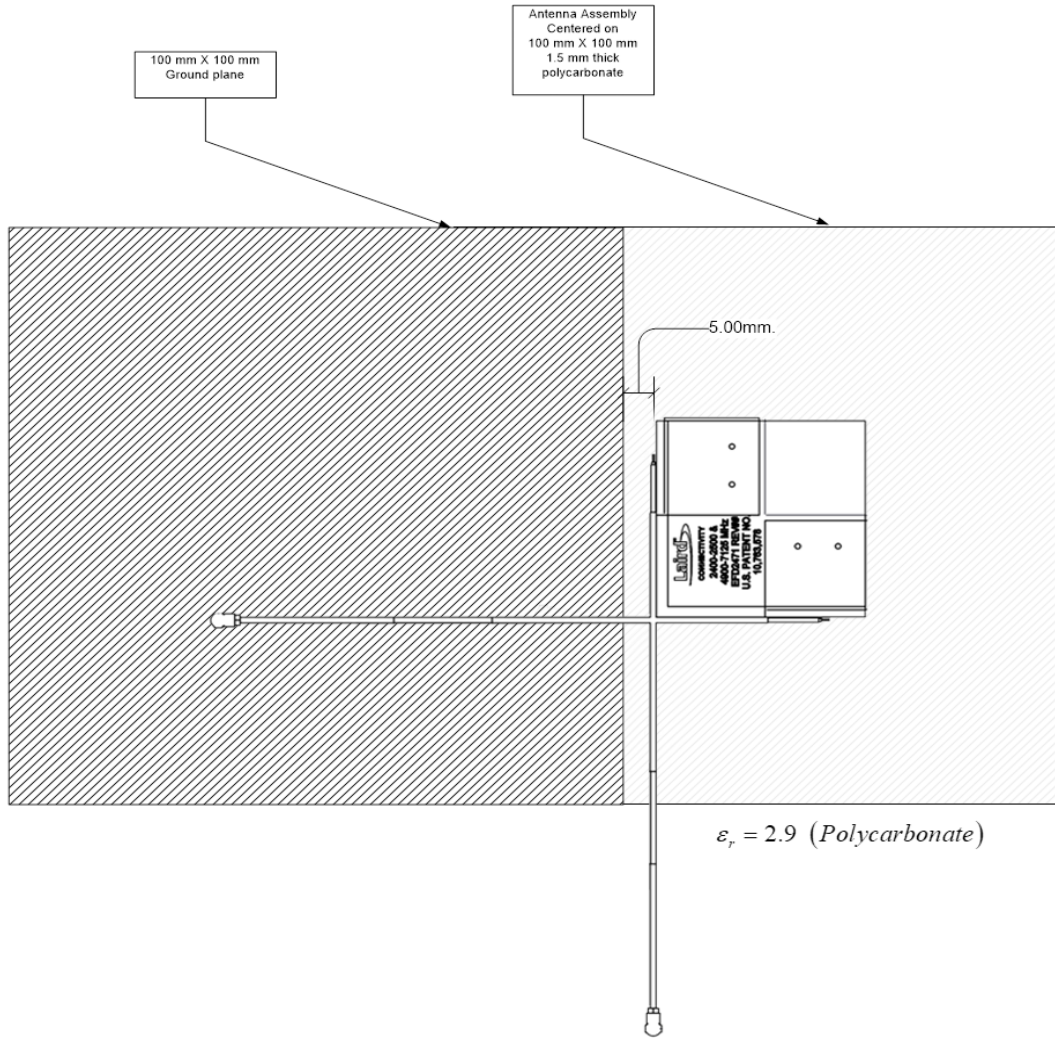

Figure 2: Minimum clearance between co-planar edge-coupled ground planes for one placement instance

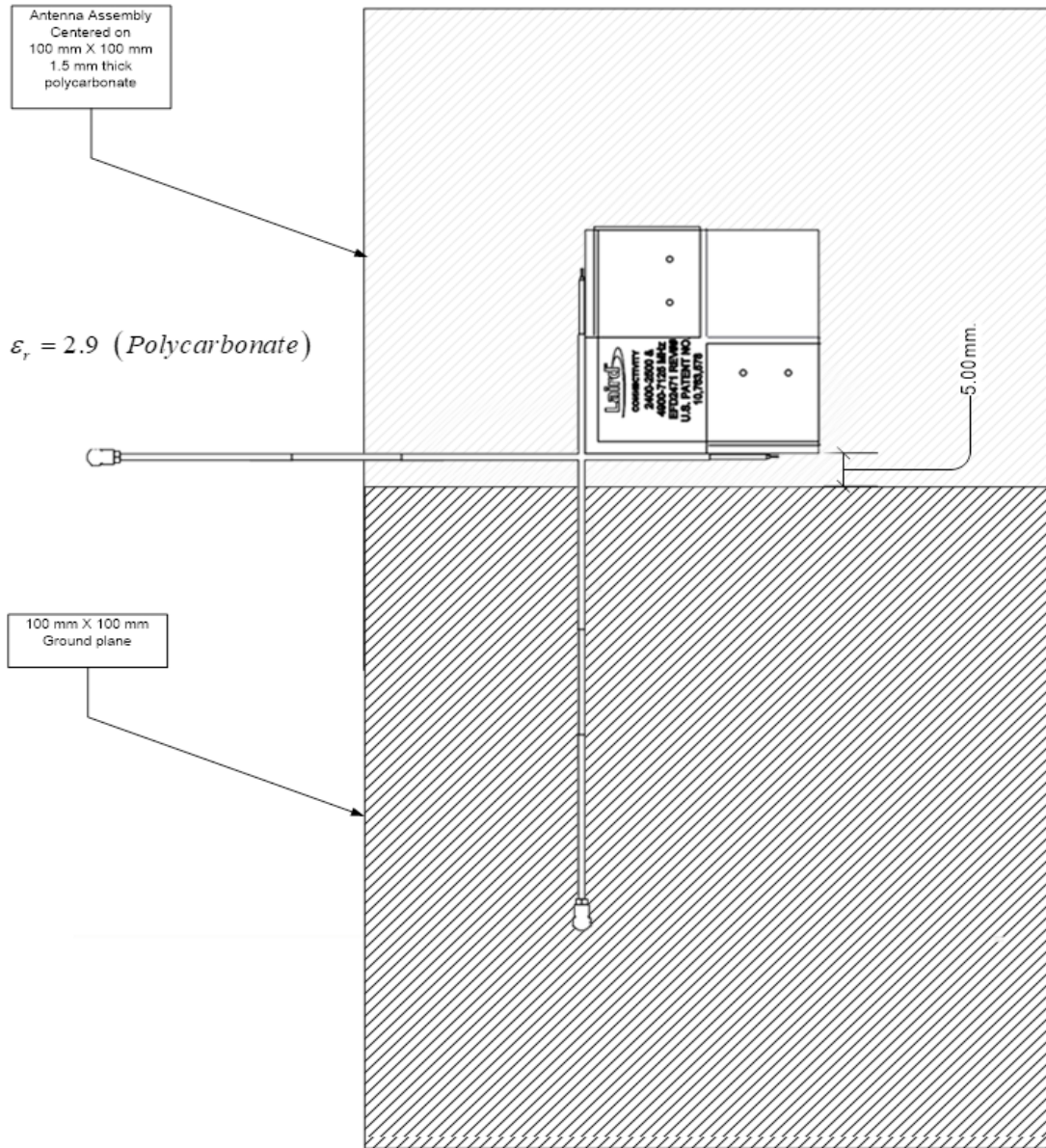

Figure 3: Minimum clearance between co-planar edge-coupled ground planes for another placement instance

Parallel Ground Plane Placement and Clearance

We recommend that a parallel ground plane not be placed either above or below the antenna array because it degrades the designed peak gain. Increased peak gain can have implications in consequent radio certifications since a maximum declared peak gain is specified as a test condition during the certification testing. Antenna with peak gain beyond the declared value for the certification can cause the device to be non-compliant.

Parallel Dielectric Sheet Loading and Clearance

A parallel dielectric sheet can be placed over the antenna with a minimum of ten millimeters as shown in Figure 4: Minimum clearance of dielectric sheet loading on top of the antenna array.

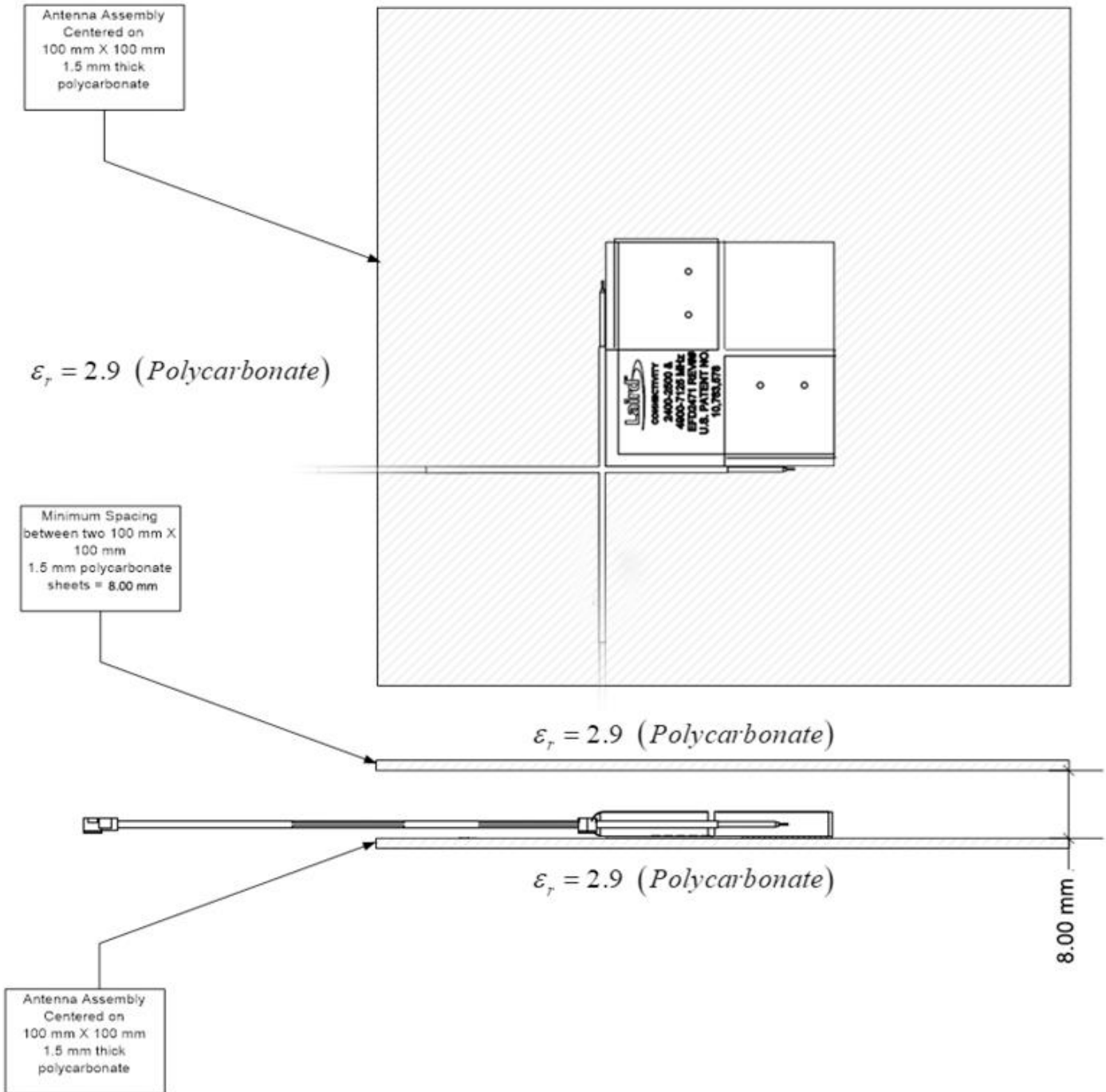

Figure 4: Minimum clearance of dielectric sheet loading on top of the antenna array

Operation on Dielectric Curved Surfaces

One of the benefits of the flexible nature of antenna array is that it can be placed on curved surfaces. The array was tested on both convex and concave curved surfaces with radii of curvature of 37.5 millimeters and 33 millimeters, respectively. The testing was performed using a 75-millimeter nominal OD (outside diameter), PVC (Polyvinyl chloride) pipe with an average thickness of 2.5 millimeters.

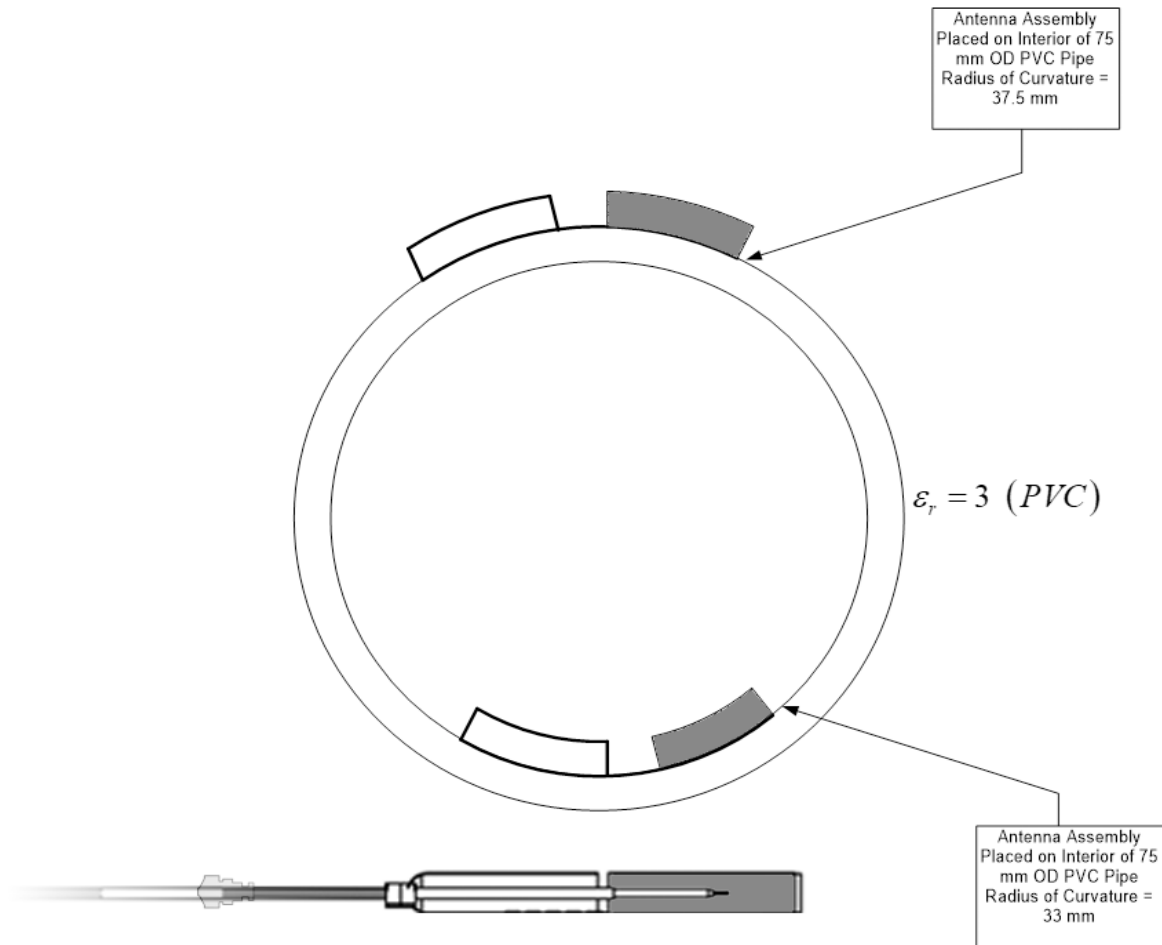

Figure 5: Operation of the antenna array on a dielectric curved surface

Summary Recommendations

We recommend the following:

- Initial placement: Place on any dielectric sheet or surface
 - Nominal material thickness – 1.5 mm
 - Relative dielectric constant – Approximately 3
- Clearance to Co-planar, edge-coupled ground planes – 5 mm (minimum)
- Clearance to Parallel Ground Planes – Not recommended
- Clearance to Parallel Dielectric Sheet above antenna array – 8 mm
- Operation on curved surfaces:
 - Convex radius of curvature – 37.5 mm (typical)
 - Concave radius of curvature – 33 mm (typical)

PACKAGING INFORMATION

Carton Layout

Unit Carton

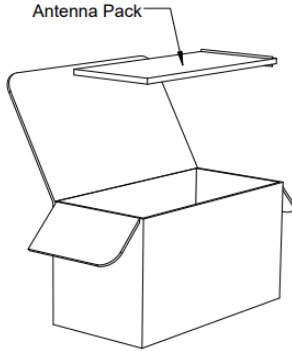

- Dimensions: 253 mm x 126 mm x 148 mm
- Antennas are in individual 102 mm x 152 mm zipper bags within 151 mm x 248 mm Zipper bag (10 antennas per bag with one desiccant). Five 10 pc bags are in 305 mm x 355 mm zipper bag.
- Two, 50pc bags per carton (100antennas total)

Master Carton

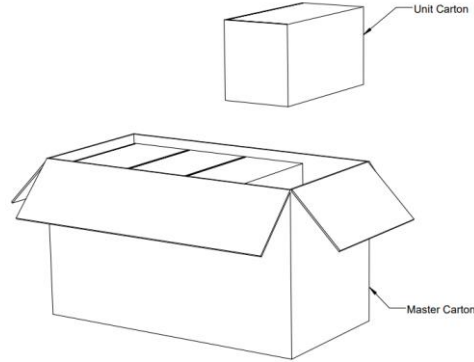

- Dimensions: 530mm x 270 mm x 318 mm
- Total of 8-unit cartons per master carton
- Total of 800 antennas per master carton

Pallet Layout

Ocean Shipping Pallet

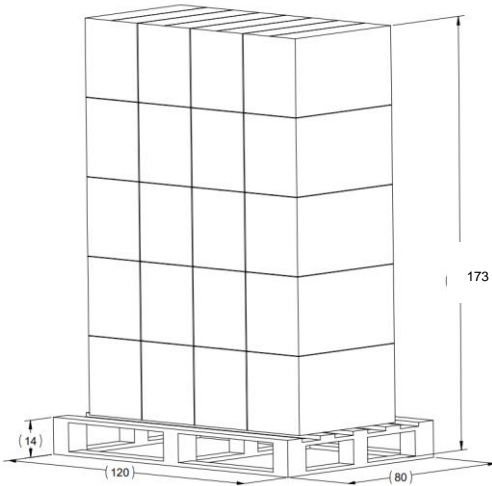

- Pallet base dimensions: 120 cm x 80 cm x 14 cm
- Full loaded dimensions: 120 cm x 80 cm x 173 cm
- 20 master cartons (4 x 5 layout), 60 kg total
- 16,000 antennas per pallet

Air Shipping Pallet

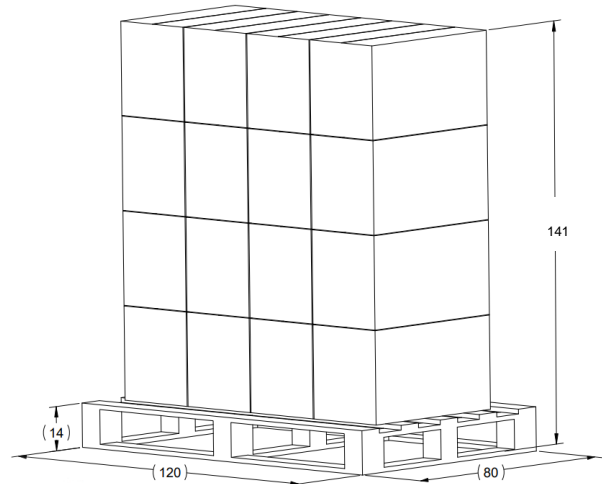

- Pallet base dimensions: 120 cm x 80 cm x 14 cm
- Full loaded dimensions: 120 cm x 80 cm x 144 cm
- 16 master cartons (4 x 4 layout)
- 12,800 antennas per pallet

sales@lairdconnect.com
support@lairdconnect.com
www.lairdconnect.com

© Copyright 2022 Laird Connectivity. All Rights Reserved. Patent pending. Any information furnished by Laird Connectivity and its agents is believed to be accurate and reliable. All specifications are subject to change without notice. Responsibility for the use and application of Laird Connectivity materials or products rests with the end user since Laird Connectivity and its agents cannot be aware of all potential uses. Laird Connectivity makes no warranties as to non-infringement nor as to the fitness, merchantability, or sustainability of any Laird Connectivity materials or products for any specific or general uses. Laird Connectivity or any of its affiliates or agents shall not be liable for incidental or consequential damages of any kind. All Laird Connectivity products are sold pursuant to the Laird Connectivity Terms and Conditions of Sale in effect from time to time, a copy of which will be furnished upon request. Nothing herein provides a license under any Laird Connectivity or any third-party intellectual property right.